

**Applications**

- Switch Mode Power Supply ( SMPS )
- Uninterruptable Power Supply
- High speed power switching

<b>V<sub>DSS</sub></b>	<b>R<sub>ds(on)</sub> max</b>	<b>I<sub>D</sub></b>
<b>500V</b>	<b>0.24Ω</b>	<b>20A</b>

**Benefits**

- Low Gate Charge Q<sub>g</sub> results in Simple Drive Requirement
- Improved Gate, Avalanche and dynamic dv/dt Ruggedness
- Fully Characterized Capacitance and Avalanche Voltage and Current
- Effective Coss specified ( See AN1001)



**Absolute Maximum Ratings**

	<b>Parameter</b>	<b>Max.</b>	<b>Units</b>
I <sub>D</sub> @ T <sub>C</sub> = 25°C	Continuous Drain Current, V <sub>GS</sub> @ 10V	20	A
I <sub>D</sub> @ T <sub>C</sub> = 100°C	Continuous Drain Current, V <sub>GS</sub> @ 10V	13	
I <sub>DM</sub>	Pulsed Drain Current ①	80	
P <sub>D</sub> @ T <sub>C</sub> = 25°C	Power Dissipation	280	W
	Linear Derating Factor	2.2	W/°C
V <sub>GS</sub>	Gate-to-Source Voltage	± 30	V
dv/dt	Peak Diode Recovery dv/dt ③	5.0	V/ns
T <sub>J</sub>	Operating Junction and	-55 to + 150	°C
T <sub>STG</sub>	Storage Temperature Range		
	Soldering Temperature, for 10 seconds	300 (1.6mm from case )	
	Mounting torque, 6-32 or M3 screw	10 lbf•in (1.1N•m)	

**Typical SMPS Topologies:**

- Full Bridge
- PFC Boost

Notes ① through ⑤ are on page 8  
www.irf.com

# IRFP460N

International  
IR Rectifier

Static @  $T_J = 25^\circ\text{C}$  (unless otherwise specified)

	Parameter	Min.	Typ.	Max.	Units	Conditions
$V_{(BR)DSS}$	Drain-to-Source Breakdown Voltage	500	—	—	V	$V_{GS} = 0V, I_D = 250\mu A$
$\Delta V_{(BR)DSS}/\Delta T_J$	Breakdown Voltage Temp. Coefficient	—	0.58	—	V/ $^\circ\text{C}$	Reference to $25^\circ\text{C}, I_D = 1\text{mA}$
$R_{DS(on)}$	Static Drain-to-Source On-Resistance	—	—	0.24	$\Omega$	$V_{GS} = 10V, I_D = 12A$ ④
$V_{GS(th)}$	Gate Threshold Voltage	3.0	—	5.0	V	$V_{DS} = V_{GS}, I_D = 250\mu A$
$I_{DSS}$	Drain-to-Source Leakage Current	—	—	25	$\mu A$	$V_{DS} = 500V, V_{GS} = 0V$
		—	—	250		$V_{DS} = 400V, V_{GS} = 0V, T_J = 125^\circ\text{C}$
$I_{GSS}$	Gate-to-Source Forward Leakage	—	—	100	nA	$V_{GS} = 30V$
	Gate-to-Source Reverse Leakage	—	—	-100		$V_{GS} = -30V$

Dynamic @  $T_J = 25^\circ\text{C}$  (unless otherwise specified)

	Parameter	Min.	Typ.	Max.	Units	Conditions
$g_{fs}$	Forward Transconductance	10	—	—	S	$V_{DS} = 50V, I_D = 12A$
$Q_g$	Total Gate Charge	—	—	124	nC	$I_D = 20A$ $V_{DS} = 400V$ $V_{GS} = 10V$ , See Fig. 6 and 13 ④
$Q_{gs}$	Gate-to-Source Charge	—	—	40		
$Q_{gd}$	Gate-to-Drain ("Miller") Charge	—	—	57		
$t_{d(on)}$	Turn-On Delay Time	—	23	—		
$t_r$	Rise Time	—	87	—	ns	$V_{DD} = 250V$ $I_D = 20A$ $R_G = 4.3\Omega$ $R_D = 13\Omega$ , See Fig. 10 ④
$t_{d(off)}$	Turn-Off Delay Time	—	34	—		
$t_f$	Fall Time	—	33	—		
$C_{iss}$	Input Capacitance	—	3540	—	pF	$V_{GS} = 0V$ $V_{DS} = 25V$ $f = 1.0\text{MHz}$ , See Fig. 5
$C_{oss}$	Output Capacitance	—	350	—		
$C_{rss}$	Reverse Transfer Capacitance	—	30	—		
$C_{oss}$	Output Capacitance	—	3930	—		
$C_{oss}$	Output Capacitance	—	95	—		
$C_{oss\ eff.}$	Effective Output Capacitance	—	200	—		

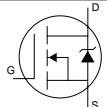
## Avalanche Characteristics

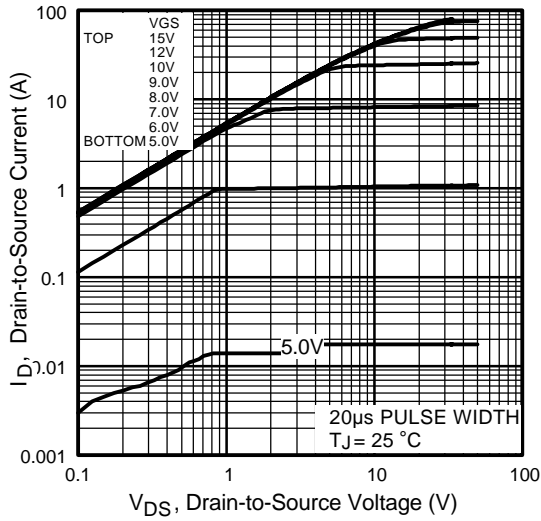
	Parameter	Typ.	Max.	Units
$E_{AS}$	Single Pulse Avalanche Energy②	—	340	mJ
$I_{AR}$	Avalanche Current①	—	20	A
$E_{AR}$	Repetitive Avalanche Energy①	—	28	mJ

## Thermal Resistance

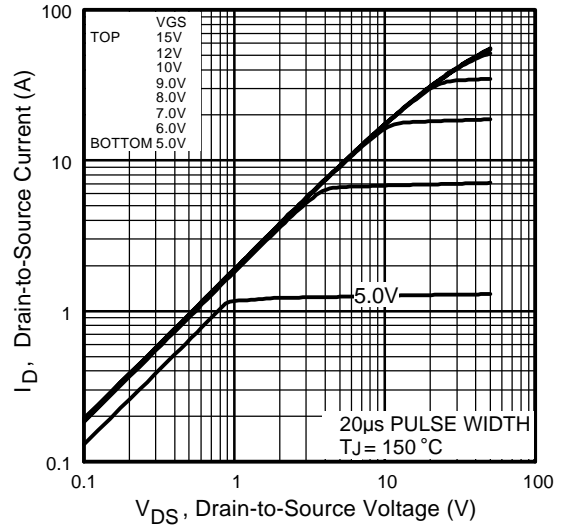
	Parameter	Typ.	Max.	Units
$R_{\theta JC}$	Junction-to-Case	—	0.45	$^\circ\text{C}/\text{W}$
$R_{\theta CS}$	Case-to-Sink, Flat, Greased Surface	0.24	—	
$R_{\theta JA}$	Junction-to-Ambient	—	40	

## Diode Characteristics

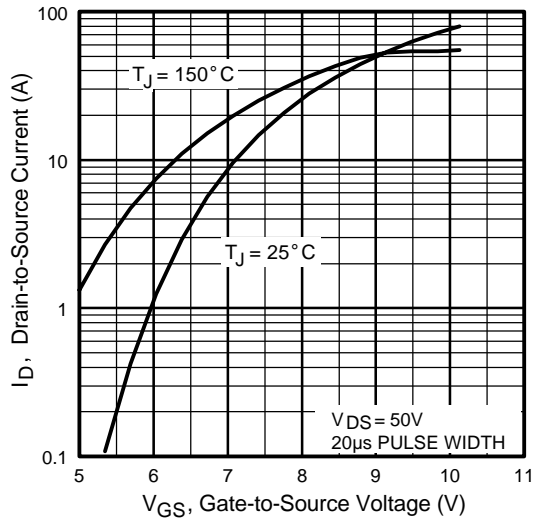
	Parameter	Min.	Typ.	Max.	Units	Conditions
$I_S$	Continuous Source Current (Body Diode)	—	—	20	A	MOSFET symbol showing the integral reverse p-n junction diode. 
$I_{SM}$	Pulsed Source Current (Body Diode) ①	—	—	80		
$V_{SD}$	Diode Forward Voltage	—	—	1.8	V	$T_J = 25^\circ\text{C}, I_S = 20A, V_{GS} = 0V$ ④
$t_{rr}$	Reverse Recovery Time	—	550	825	ns	$T_J = 25^\circ\text{C}, I_F = 20A$
$Q_{rr}$	Reverse Recovery Charge	—	7.2	10.8	$\mu\text{C}$	$di/dt = 100A/\mu\text{s}$ ④
$t_{on}$	Forward Turn-On Time	Intrinsic turn-on time is negligible (turn-on is dominated by $L_S + L_D$ )				



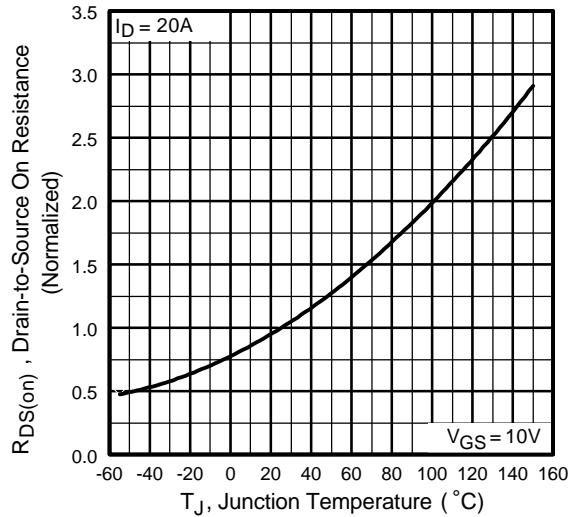
**Fig 1.** Typical Output Characteristics



**Fig 2.** Typical Output Characteristics

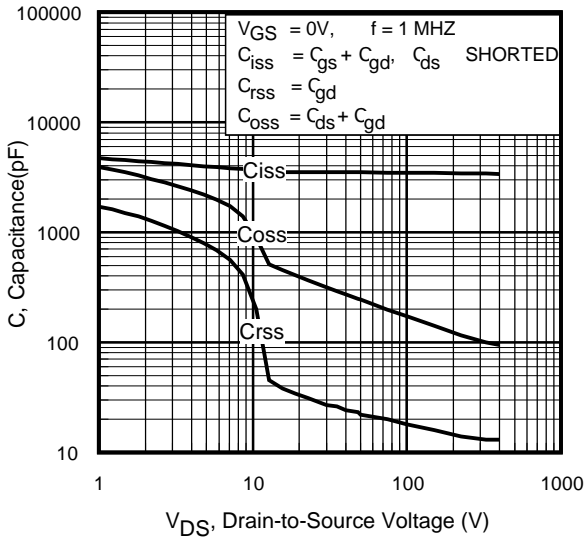


**Fig 3.** Typical Transfer Characteristics

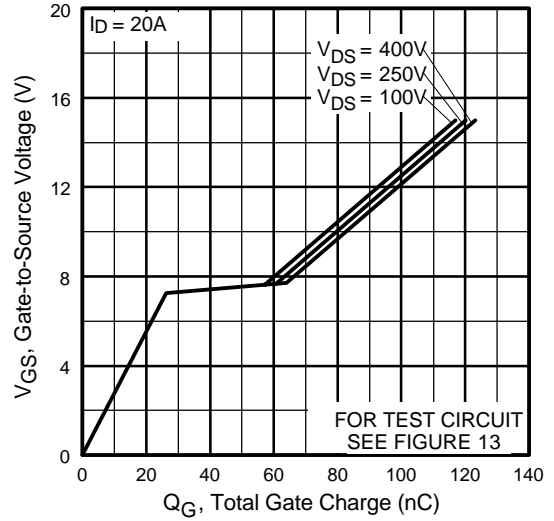


**Fig 4.** Normalized On-Resistance Vs. Temperature

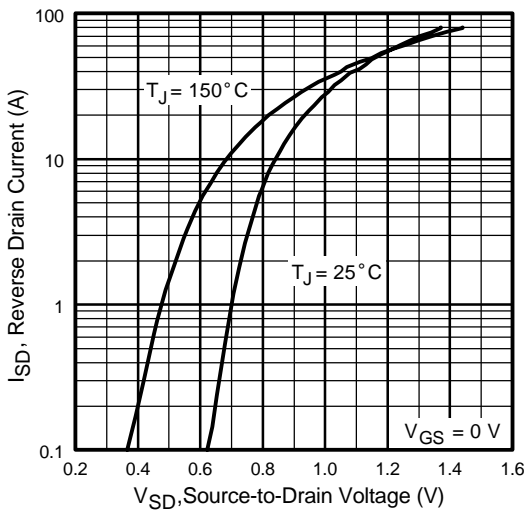
# IRFP460N



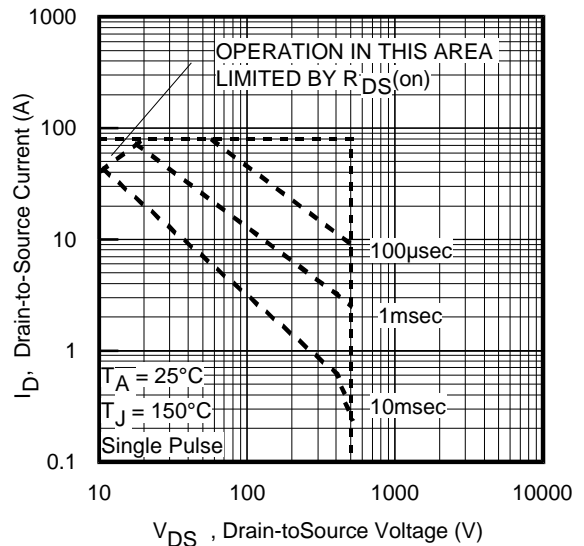
**Fig 5.** Typical Capacitance Vs. Drain-to-Source Voltage



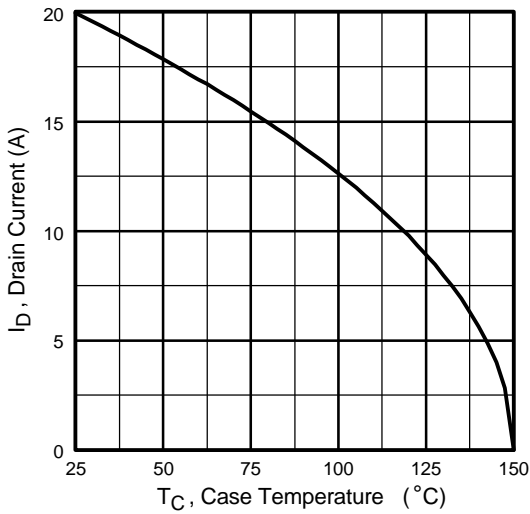
**Fig 6.** Typical Gate Charge Vs. Gate-to-Source Voltage



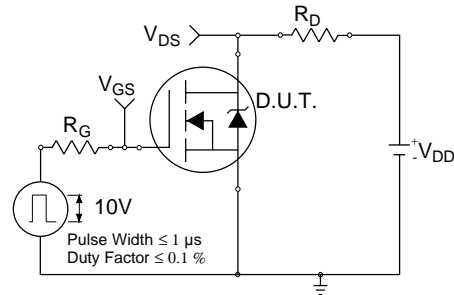
**Fig 7.** Typical Source-Drain Diode Forward Voltage



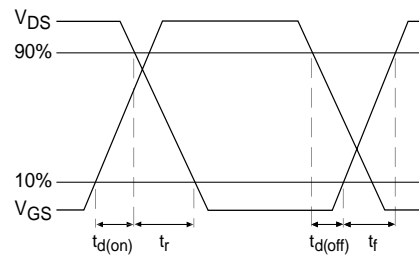
**Fig 8.** Maximum Safe Operating Area



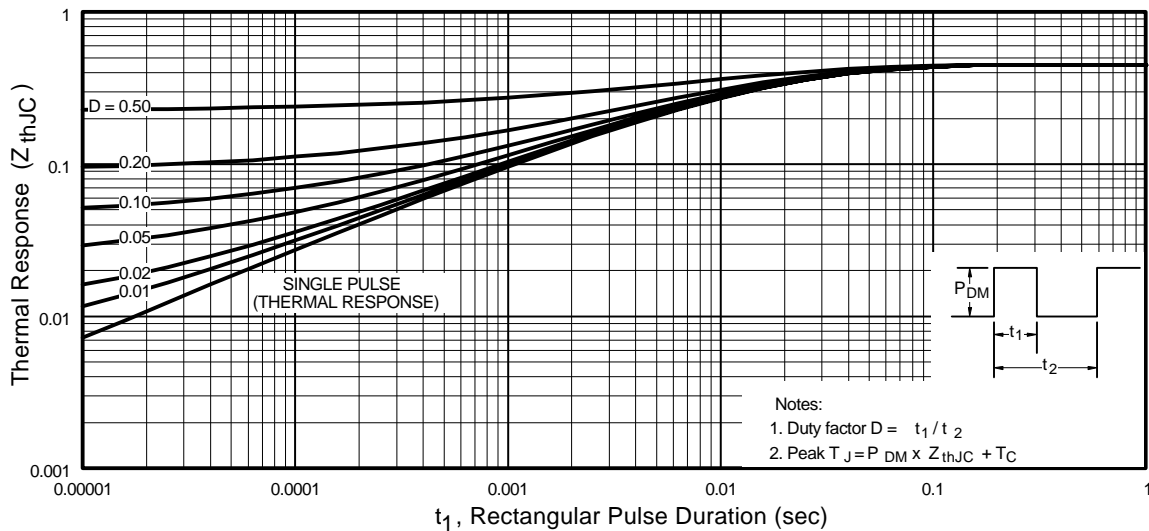
**Fig 9.** Maximum Drain Current Vs. Case Temperature



**Fig 10a.** Switching Time Test Circuit



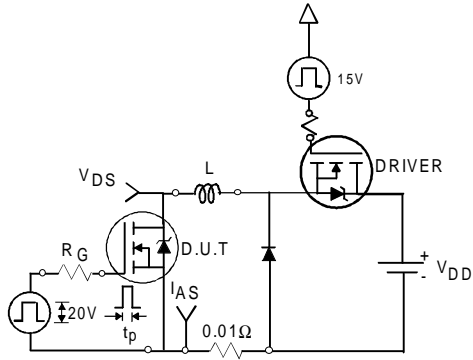
**Fig 10b.** Switching Time Waveforms



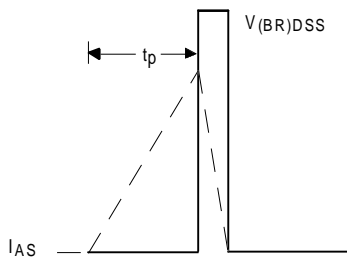
**Fig 11.** Maximum Effective Transient Thermal Impedance, Junction-to-Case

# IRFP460N

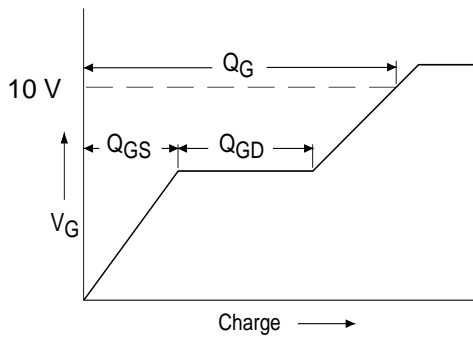
International  
**IR** Rectifier



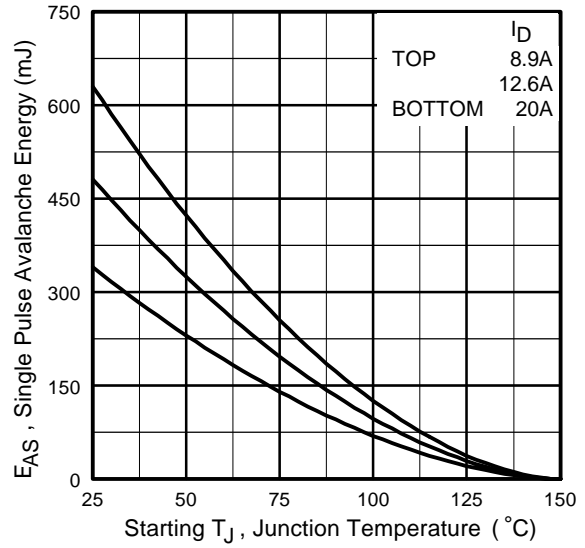
**Fig 12a.** Unclamped Inductive Test Circuit



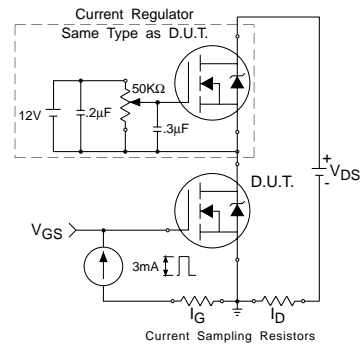
**Fig 12b.** Unclamped Inductive Waveforms



**Fig 13a.** Basic Gate Charge Waveform

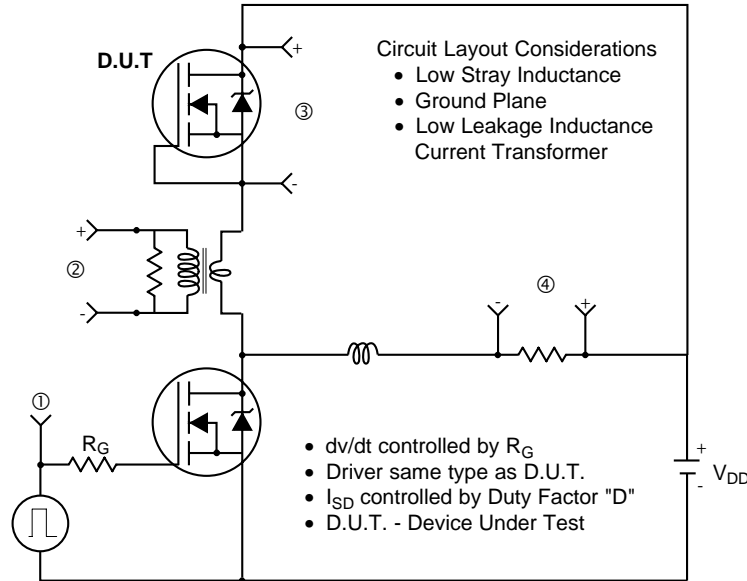


**Fig 12c.** Maximum Avalanche Energy Vs. Drain Current



**Fig 13b.** Gate Charge Test Circuit

## Peak Diode Recovery dv/dt Test Circuit



\*  $V_{GS} = 5V$  for Logic Level Devices

**Fig 14.** For N-Channel HEXFETS

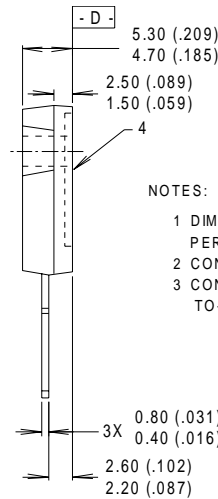
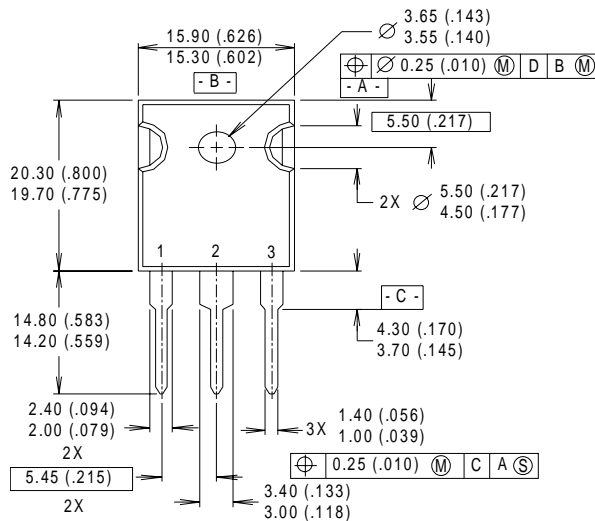
# IRFP460N

## Package Outline

### TO-247AC

International  
**IR** Rectifier

Dimensions are shown in millimeters (inches)



#### NOTES:

- 1 DIMENSIONING & TOLERANCING PER ANSI Y14.5M, 1982.
- 2 CONTROLLING DIMENSION : INCH.
- 3 CONFORMS TO JEDEC OUTLINE TO-247-AC.

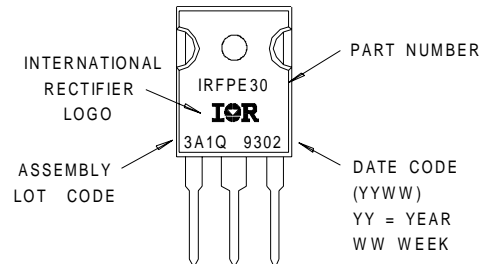
#### LEAD ASSIGNMENTS

- 1 - GATE
- 2 - DRAIN
- 3 - SOURCE
- 4 - DRAIN

## Part Marking Information

### TO-247AC

EXAMPLE : THIS IS AN IRFPE30  
WITH ASSEMBLY  
LOT CODE 3A1Q



#### Notes:

- ① Repetitive rating; pulse width limited by max. junction temperature. ( See fig. 11 )
- ② Starting  $T_J = 25^\circ\text{C}$ ,  $L = 1.8\text{mH}$   
 $R_G = 25\Omega$ ,  $I_{AS} = 20\text{A}$ . (See Figure 12)
- ③  $I_{SD} \leq 20\text{A}$ ,  $di/dt \leq 140\text{A}/\mu\text{s}$ ,  $V_{DD} \leq V_{(BR)DSS}$ ,  
 $T_J \leq 150^\circ\text{C}$
- ④ Pulse width  $\leq 300\mu\text{s}$ ; duty cycle  $\leq 2\%$ .
- ⑤  $C_{OSS}$  eff. is a fixed capacitance that gives the same charging time as  $C_{OSS}$  while  $V_{DS}$  is rising from 0 to 80%  $V_{DSS}$

This product has been designed and qualified for the industrial market.  
Qualification Standards can be found on IR's Web site.

International  
**IR** Rectifier

IR WORLD HEADQUARTERS: 233 Kansas St., El Segundo, California 90245, USA Tel: (310) 252-7105  
TAC Fax: (310) 252-7903

Visit us at [www.irf.com](http://www.irf.com) for sales contact information.

Data and specifications subject to change without notice. 05/01

[www.irf.com](http://www.irf.com)